



GEEPLUS

VM102P2

P_{100} is the continuous (100% ED) excitation power at which the coil attains temperature T_{max} with the part mounted to a massive heatsink at 20°C

P_{100} 105 W

T_{max} 130 °C

Total Mass 4200 g

Coil Mass 430 g

Model No.	Resistance R_{20}	Inductance	Force Constant	Velocity Constant	Current I_{100}
VM102P2-710	2.1 Ω	0.6 mH	35 N/A	35 Vs/m	6.0 A
VM102P2-475	10.5 Ω	3.0 mH	78 N/A	78 Vs/m	2.7 A
VM102P2-355	33.4 Ω	9.5 mH	138 N/A	138 Vs/m	1.5 A

	Max 'ON' time	Peak Force
100% ED	∞	208.0 N
50% ED	100 s	297.0 N
25% ED	35 s	430.0 N
10% ED	12 s	645.0 N

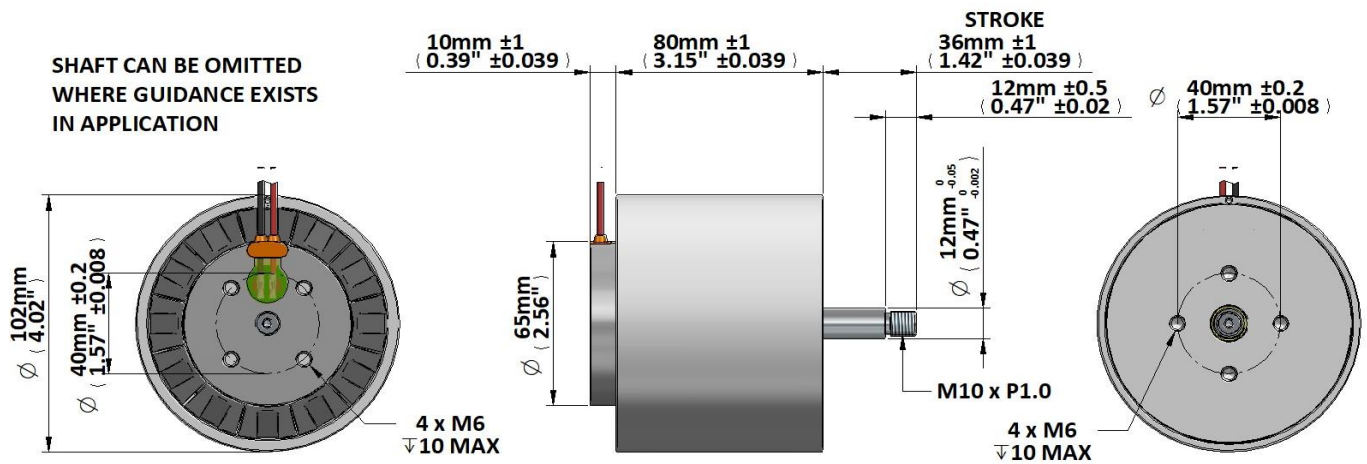

Force (N) vs Displacement (mm)

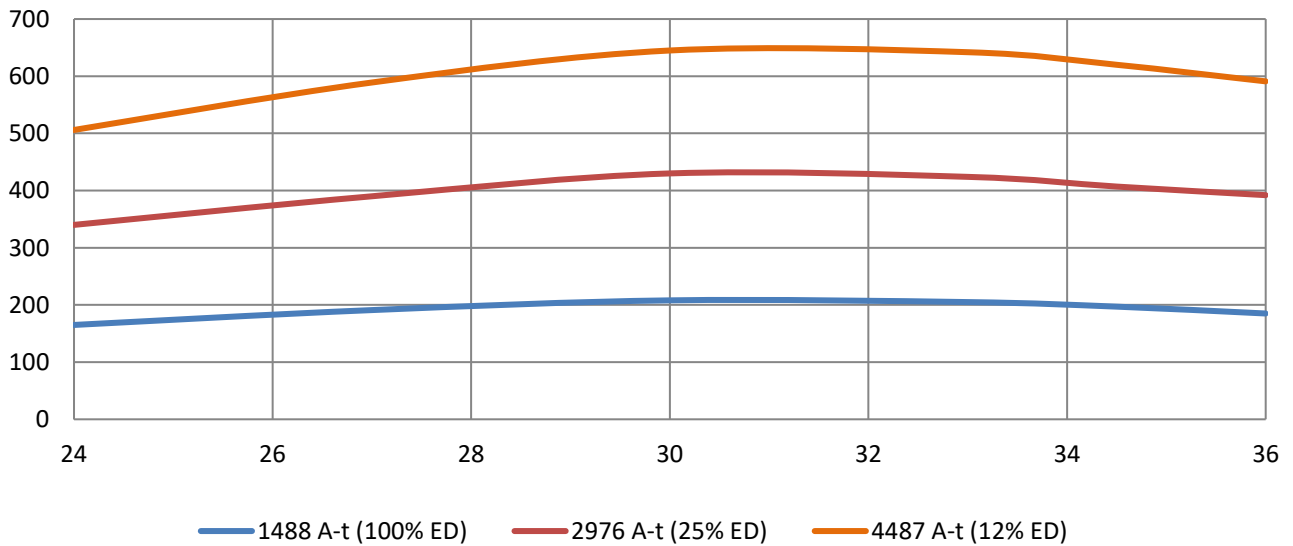

Geeplus reserves the right to change specifications without notice

www.geeplus.com