



SUGATSUNE

LAMP

No.240

PRODUCT HIGHLIGHTS

A selection of products from our **LAMP** brand



History of SUGATSUNE

Offices in Japan

Tokyo Head Office



Global Headquarter

Tokyo Showroom



Kanagawa



Osaka

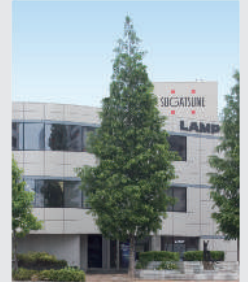

Nagoya



Kyoto



Fukuoka

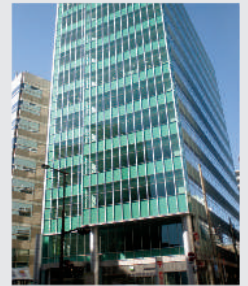

Sendai

Signature LAPCON products.
SDS soft-down stay begins production.

1988

“LAPCON” soft-close dampening technology is developed and
launched first LAPCON products, Tallman-Closet Rod System.

1987

Sugatsune Japan head Office renovated
new building in central Tokyo.

1985

Sugatsune America is founded
in Los Angeles, California.

1982

1975

First branch Office is opened in Osaka, Japan.

1972

Obtained International patent with
magnetic door holder in 12 different countries.

1955

Special hardware is supplied
to the household of the Japanese emperor.

1943

First Factory in Tokyo, Japan is opened.

1930

Sugatsune Kogyo is founded by Tsunesaburo Sugawara.

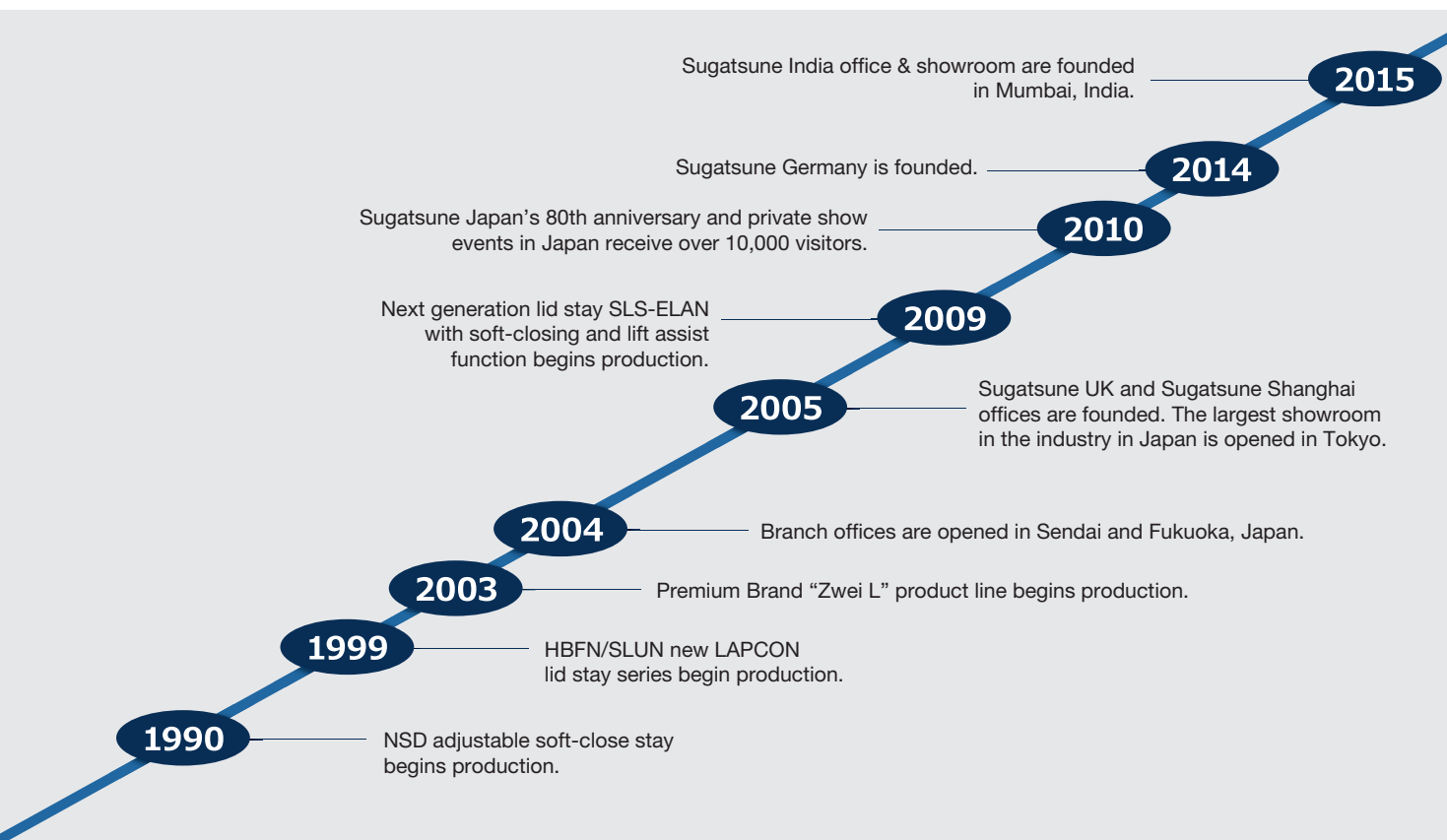

Overseas Branches

Reading, UK



Shanghai, CHINA



Guangzhou, CHINA

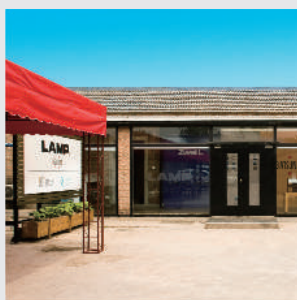

Mumbai, INDIA



California, USA



Chicago, USA



Düsseldorf, GERMANY



Experience meets innovation

SUGATSUNE hardware stands out thanks to the highest quality and innovative design. As a Japanese manufacturer of premium furniture, architectural and industrial hardware steeped in tradition, SUGATSUNE is highly regarded throughout the world. Our customers commend our 6,000+ products for their functionality, durability and our attention to detail.

Whether excellent handles and knobs, hinges, or space-saving opening mechanisms, you are bound to find whatever special solution you are looking for! Interior architects as well as customers from the marine and the medical industry alike are thrilled with the wide range including numerous stainless steel products.

Thanks to our branch in Düsseldorf, Germany, SUGATSUNE EUROPE GMBH is now able to assist customers in Europe* with any questions in both German and English. We can also ensure short delivery times throughout Europe due to our on-site warehouse and a constantly growing sales network. We look forward to supporting you in finding the perfect solution for your project.



CONTENTS

Icon Definitions

	Test method		STAINLESS STEEL 430 Stainless Steel
	Lapcon Patented products as Lapcon		STAINLESS STEEL 302 Stainless Steel
	SCREW Steel Screw		STAINLESS STEEL 303 Stainless Steel
	SCREW Stainless Steel Screw		STAINLESS STEEL 304 Stainless Steel
	Non-handed Available for both sides		STAINLESS STEEL 316 Stainless Steel

PRODUCTS

- HANDLES, PULLS & KNOBS 5
- HOOKS 6–7
- CATCHES & LATCHES 8–10
- HINGES 11–13
- LID SUPPORTS 15–17
- DRAWER SLIDES 18
- ARCHITECTURAL DOOR HARDWARE 19
- WARDROBE & CABINET DOOR HARDWARE 20–21
- MISCELLANEOUS 22–23

is the name of the SUGATSUNE patented dampening technology.

LAMP is a SUGATSUNE brand.

*If you are a customer from Great Britain, Norway, Sweden, Denmark, Ireland or Iceland please continue to contact Sugatsune Kogyo (UK) Ltd.



STAINLESS STEEL HANDLE XL-JS

- **Material**
Stainless Steel (SUS316)
- **Finish**
Combination of Mirror and Satin



STAINLESS STEEL HANDLE FT-200, FT-280

- **Material**
Stainless Steel (SUS316)
- **Finish**
Mirror



STAINLESS STEEL HANDLE US

- **Features**
 - Rubber grip allows for an easy and comfortable grip
 - Light weight design
- **Material**
 - Elastomer (TPE)
 - Stainless Steel (SUS304)
- **Finish**
 - Satin
 - Mirror



RECESSED PULL UTZ-130

- **Material**
 - Zinc Alloy (ZDC)
 - Plastic
- **Finish**
 - Satin Nickel
 - Chrome
 - Bronze



STAINLESS STEEL HATCH PULL ST-90, ST-115

- **Material**
Stainless Steel (SUS304)
- **Finish**
Satin



TRUNK HANDLE MUD-140

- **Material**
 - Body
Zinc Alloy (ZDC)
 - Grip
Zinc Alloy (ZDC) / Elastomer (TPE)
- **Finish/Colour**
 - Body
Chrome
 - Grip
Chrome / Black



STAINLESS STEEL KNOB RSS

- **Material**
Stainless Steel (SUS304)
- **Finish**
 - Satin
 - Mirror



STAINLESS STEEL PULL RD

- **Material**
Stainless Steel (SCS14)
- **Finish**
Mirror

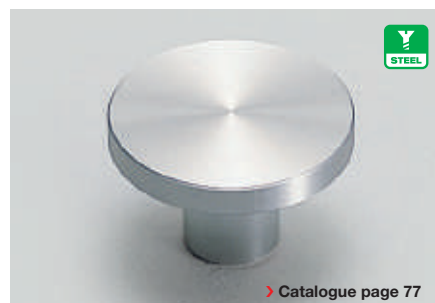

KNOB EXSEL

- **Material**
Aluminium Alloy
- **Finish**
Stainless Anodized



**LATCH HOOK
EN-R100F**

- **Features**
- Swivels 180°
 - Clip to prevent hooked items from falling off
 - Suitable for exterior use (e.g. marine, housing, shops and leashes for pets)
- **Finish**
Mirror



**LATCH HOOK
EN-E107**

- **Features**
- Clip to prevent hooked items from falling off
 - One push release for wide opening
- **Finish**
Mirror



**LARGE LATCH HOOK
JN-T100**

- **Features**
- Swivels 180°
 - Hook has constant torque when swivelling
 - Clip to prevent hooked items from falling off
- **Finish**
Mirror



**BUTTERFLY HOOK
DZ-270**

- **Features**
- Can be installed on flat surface, corner and edge
 - Both vertical and horizontal use possible
- **Finish**
Polished



**SWING HOOK
UC**

- **Features**
Swings 180°
- **Finish**
Polished



**ROTATING SWING HOOK
RF-U50**

- **Features**
Rotates 360° and swings 180°
- **Finish**
Satin



**SWING HOOK
TK, TKF**

- **Features**
- w/ friction type and w/o friction type available
 - Swings 180°
- **Finish**
Polished



**BUTTERFLY HOOK
TZ-360**

- **Features**
Can be used in various applications
- **Finish**
Polished



**HOOK
FC**

- **Features**
- The rounded tip provides safety
 - Titanium screws available by special order
- **Finish**
Shot Blast / Mirror

WIRE HOOK TY
■ Features

The rounded tip provides safety

■ Finish

Polished

WIRE HOOK TF
■ Features

The rounded tip provides safety

■ Finish

Polished

WIRE HOOK TL
■ Features

The rounded tip provides safety

■ Finish

Polished

HOOK EU
■ Features

- Can hang 3 items at same time
- Two-tip shape ideal to hang hats, caps etc.

■ Finish

Mirror

HOOK HJ
■ Features

- Perfect as a hanger underneath tables, bars etc.

■ Finish

Satin / Black

HOOK KB-H
■ Finish

Mirror

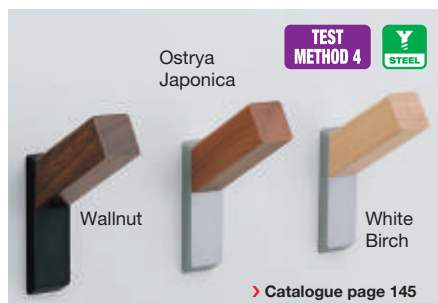
COAT HOOK (PREMIUM WOOD SERIES) PXB-WM
■ Features

- The contrast of the gentle touch of wood surface and shiny metallic texture creates a unique rectilinear feature
- Metal core inside the wooden arm provides

■ high-durability

- Clear coating greatly improves the endurance

■ Finish/Colour (Base Cover)

Silver / Black

RUBBER HOOK (VIVID COLOUR) PXB-GR05-2
■ Features

- Simple and safe design
- Base made of SUS304 provides high-durability
- Offers a wide range of colours

■ Colour

- Red
- Yellow
- White
- Green
- Blue

RUBBER HOOK (NORDIC COLOUR) PXB-GN
■ Features

- Simple and safe design
- Base made of SUS304 provides high-durability
- Designed to fit in all kinds of interior

■ Colour

- Dark Grey
- Brown
- Beige



PUSH KNOB LATCH DPL

- **Features**
 - Safe and smart design: door will be locked when knob is pushed in
 - Can be used for overlay and inset door (door thickness: 15-25 mm)
 - Door stopper is not needed
- **Finish**
 - Gold (Clear/Paint)
 - Chrome
 - Satin Nickel
- Latch and knob are sold as a set

> Catalogue page 227



PUSH KNOB LATCH PKL-08

- **Features**
 - Safe and smart design: door will be locked when knob is pushed in
 - Can be used for overlay and inset door (door thickness: 15-30 mm). For thin door, please use a plastic spacer (sold separately)
- **Finish**
 - Gold
 - Chrome
 - Black Nickel

> Catalogue page 229



PUSH KNOB LATCH TLP-S

- **Features**
 - Safe and smart design: door will be locked when knob is pushed in
 - Flexible to suit door thickness by adjusting screw
 - Spring loaded latch keeps the door closed
- Can be used for overlay and inset door (door thickness: 19-30 mm)
- **Finish**
 - Chrome
 - Gold
 - Satin Nickel

> Catalogue page 231



MAGNETIC TOUCH LATCH ML-120

- **Features**
 - The rotary cam mechanism offers a longer life than the usual spring mechanism
 - No handle needed, just push to open/close
- **Colour**
 - Brown / White

> Catalogue page 238



NON-MAGNETIC TOUCH LATCH MLC-HT130BL

- **Features**
 - Heat-resistance (up to 120°C) and long stroke
 - No handle needed, just push to open/close
 - Non magnetic
- Wide adjustment range: ±2 mm vertically and ±3.5 mm horizontally
- Passed 100,000 times opening and closing test

> Catalogue page 242



NON-MAGNETIC TOUCH LATCH MC-37F

- **Features**
 - No handle needed, just push to open/close
 - Floating strike for easy alignment
 - Non magnetic
 - Passed 100,000 times opening and closing test
- **Colour**
 - Black
 - Brown
 - White

> Catalogue page 243

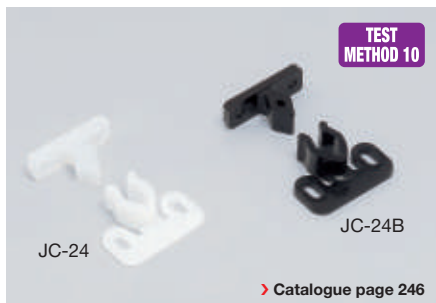

KNUCKLE CATCH JC-24/26

- **Features**
 - Resin body prevents rust
 - Suitable for general furniture, kitchen equipment and marine hardware
- Can be used for overlay and inset door

> Catalogue page 246

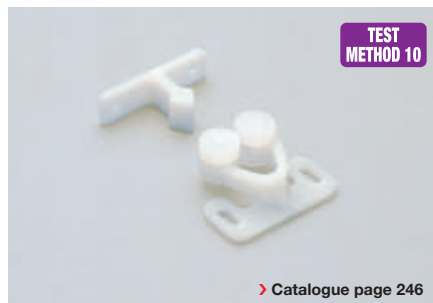

ROTARY CATCH RC6900

- **Features**
 - Resin body prevents rust
 - Suitable for general furniture, kitchen equipment and marine hardware
- Passed 100,000 times opening and closing test
- Can be used for overlay and inset door

> Catalogue page 246



KNUCKLE CATCH NAC

- **Features**
 - Holds door tightly and suitable for large door
 - High durability
 - Can be used for overlay and inset door

> Catalogue page 246

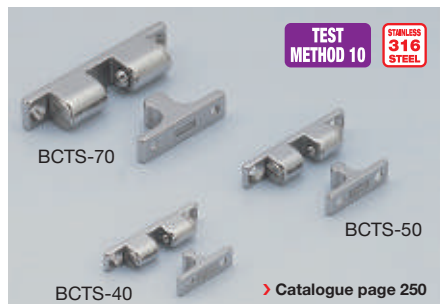

TENSION CATCH BCTS

■ **Features**

- Can be installed vertically or horizontally
- Corrosion resistance: Made of SCS14

> Catalogue page 250



MAGNETIC CATCH MC-YS

■ **Features**

- Ultra thin magnetic catch ideal for tight space
- Extra strong magnetic force: MC-YS001, MC-YS001P

- Weaker magnetic force: MC-YS002, MC-YS002P

> Catalogue page 252



MAGNETIC CATCH MC-159-SUS

■ **Features**

- Anti rust: made of stainless steel and coated with acrylic resin
- Ultra thin and extra strong magnetic force

■ **Remarks**

- Max. temperature: 80°C

> Catalogue page 263



MAGNETIC CATCH MC-YC-06

■ **Features**

- Strong die casted body
- Small body with strong magnetic force
- Can be installed vertically or horizontally

> Catalogue page 264



SEALED MAGNETIC CATCH MC-JM45

■ **Features**

- Resin sealing the magnet prevents rusting
- Thin magnetic catch ideal for tight spaces
- Strong magnetic force

- Ideal for kitchen equipment by using with the counter plate MC-JMP45

■ **Colour**

- White
- Black

> Catalogue page 270



SEALED MAGNETIC CATCH MC-JM50

■ **Features**

- Resin body prevents rusting
- Ideal for kitchen or bath equipment by using with the counter plate MC-JMP45

■ **Colour**

- White
- Black

> Catalogue page 271



STAINLESS STEEL DRAW LATCH SCC-TF30

■ **Finish**

- Mirror
- Satin

> Catalogue page 275



STAINLESS STEEL COMPRESSION DRAW LATCH SCC-40

■ **Finish**

- Polished

> Catalogue page 276

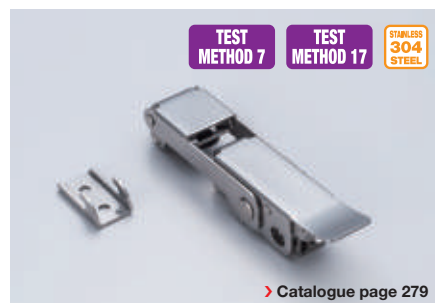

STAINLESS STEEL COMPRESSION LATCH STF-CP140

■ **Features**

- Compression arm with rubber allows to fasten the door tightly
- Compression force is adjustable

- Push safety button to release the lock
- Can be used with Padlock PWL

> Catalogue page 279



STAINLESS STEEL DRAW LATCH PN-51

- Features**
 - High corrosion (Body: SUS304, Spring: SUS316)
- Remarks**
 - Key changes are not available

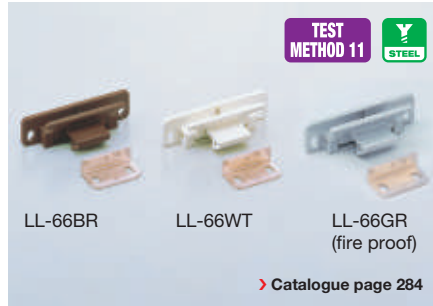

LEVER LATCH LL-66

- Features**
 - Latch designed to be used on a door without knobs and handles
 - Installation position can be adjusted (body: vertical ± 1.5 mm, counter plate: horizontal ± 1.5 mm)
- Colour**
 - Brown
 - White
 - Grey
 - Chrome



STAINLESS STEEL LEVER LATCH LL-66S

- Features**
 - Corrosion resistance: Made of 316 stainless steel
 - Latch designed to be used on a door without knobs and handles
- Installation position can be adjusted (body: vertical ± 1.5 mm, counter plate: horizontal ± 1.5 mm)
- Can be used in exterior application

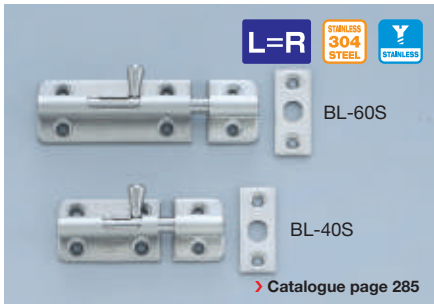

SPRING LOADED BARREL BOLT BL-S

- Features**
 - Ideal for harsh and high corrosion environments
 - Knob springs back into sleeve to keep bolt in locked or unlocked position
- Can be installed vertically or horizontally
- 2 counter plates included for different mountings

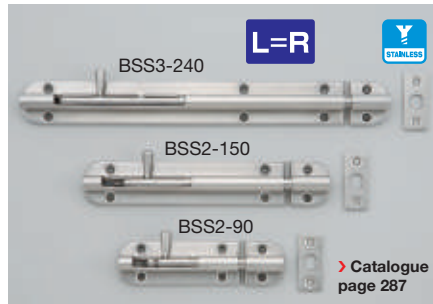

SPRING LOADED BARREL BOLT BSS 2, BSS3

- Features**
 - Extra sleeve for locking offers flexibility in application
 - Ideal for harsh and high corrosion environments
 - Knob springs back into sleeve to keep bolt in locked or unlocked position
- Can be installed vertically or horizontally
- 2 counter plates included for different mountings
- Finish**
 - Satin

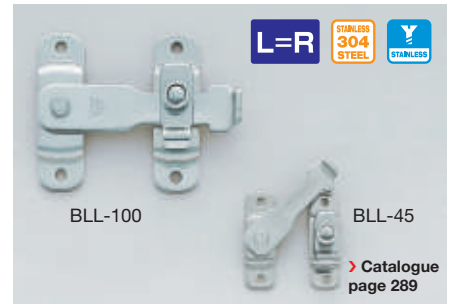

SPRING LOADED BAR LATCH BLL

- Features**
 - High corrosion resistance
 - Latch bolt snaps into the strike to prevent accidental release
 - Push tab on strike to release
- Finish**
 - Polished



SLIDE BOLT FL2

- Features**
 - Ideal for harsh and high corrosion environments
 - Easy installation, flat and compact design for various application
- 2 different counter plates included for different mountings
- Finish**
 - Satin



LEVER BOLT HR35

- Features**
 - Ideal for harsh and high corrosion environments
 - Easy installation, flat and compact design for various application
- 2 different counter plates included for different mountings
- Finish**
 - Satin



SLIDING DOOR LATCH W/INSIDE INDICATOR HC-65

- Features**
 - High corrosion resistance
 - Surface mount door latch with indicator
- Non-handed: Can be installed on left or right side
- Finish**
 - Satin



GLASS DOOR CAM LOCK 1300GL

- Features**
 - Dimple key lock series. Ideal for showcase application
 - Reversible key: lock and unlock to turn key 360° and cam turns 90°
 - Able to remove key when locked and unlocked
 - 1 million key changes available
- Master Key system available at surcharge (max. 2,520 key changes/Master Key)
 - Keys can be shared with other Million Lock Series



GLASS DOOR CAM LOCK (W/ INDICATOR) 2200GL

- Features**
 - With indicator: Unlocked - Blue, Locked - Red
 - Ideal for application of showcase or audio rack
 - Available for both right and left swing door
 - Key can be removed when locked
- 12 key changes available (max. 300 key changes as special order)
 - Master Key system (170 key changes) available at surcharge (1 master only)
 - Keys can be shared with 2200 Lock Series



CABINET LOCK 7810

- Features**
 - For right-handed doors
 - High-security
 - Reversible key. Turn the key 360° to lock or unlock
 - Available in Satin Nickel (NI), Chrome (CR), Black Chrome (BL)
- Brass cylinder lock with stainless steel body
 - 1 million key changes available. Master Key system available at surcharge (max. 2,520 key changes /Master Key)
 - Keys can be shared with other Million Lock Series



GLASS HINGE (OVERLAY, W/ CATCH) XL-GC07-CR

- Features**
 - Hinge with catch for overlay door of glass cabinet
- Can be used with XL-GC01-CR
- Finish**
 - Chrome



INSET GLASS DOOR HINGE (GLASS FRAME TYPE) GH-450G

- Features**
 - Suitable for show-cases
 - Mounting position adjustable: Horizontally -2.5 mm
- Finish/Colour**
 - SN - Satin nickel
 - CR - Chrome
 - GC - Gold



GLASS DOOR HINGE XL-GH01-250

- Features**
 - Pre-drilling on glass/acrylic not required
- Finish**
 - Mirror



3-WAY ADJUSTABLE CONCEALED HINGE HES3D-70

- Features**
 - 3-way adjustment function allows vertical, horizontal, and depth adjustment after hinge installed
 - Cover hides all screw heads for clean appearance
 - Door weight: max. 9 kg/2 pcs, 12 kg/3 pcs
 - Door thickness: min. 19 mm
- Finish**
 - DC - Satin Chrome
 - DN - Satin Nickel
 - BL - Black

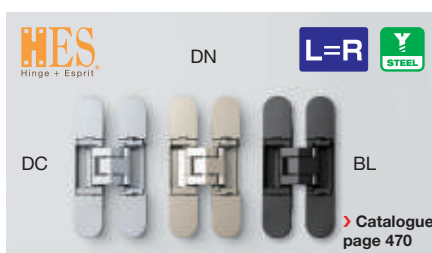

3-WAY ADJUSTABLE CONCEALED HINGE HES3D-90

- Features**
 - 3-way adjustment function allows vertical, horizontal, and depth adjustment after hinge installed
 - Cover hides all screw heads for clean appearance
 - Door weight: max. 12 kg/2 pcs, 16 kg/3 pcs
 - Door thickness: min. 23 mm
- Finish**
 - DC - Satin Chrome
 - DN - Satin Nickel
 - BL - Black



3-WAY ADJUSTABLE CONCEALED HINGE HES3D-120

- Features**
 - 3-way adjustment function allows vertical, horizontal, and depth adjustment after hinge installed
 - Cover hides all screw heads for clean appearance
 - Door weight: max. 30 kg/2 pcs, 40 kg/3 pcs
 - Door thickness: min. 29 mm
- Colour**
 - DC - Satin Chrome
 - DN - Champagne Gold
 - BL - Black



LOCK
1300GL

OUR
**HIGH-
LIGHT**

Catalogue page 368-373



Hinge J95

Hinge 100

HEAVY DUTY CONCEALED HINGE J95



■ Features

- 3-way-adjustment function by mounting plate (depth + 1.5 - 2.5 mm, vertical ± 3 mm, overlay [horizontal] + 0 - 4 mm)
- Fast one touch installation
- Max door weight: 25 kg with 2 pcs, 40 kg with 3 pcs
- It can be used for heavy door applications such as big cabinets in houses or stores

■ Advantages:

- Easy and fast adjustment (door can be adjusted by turning adjustment screws. Horizontal adjustment, vertical adjustment, depth adjustment, and tilting adjustment)
- Flat Design

■ Sold Separately

Mounting plate J95-P6T

■ Finish

Nickel

MOUNTING PLATE J95-P6T

■ Features

- Depth adjustment: + 1.5 - 2.5 mm
- Vertical adjustment: ± 3 mm
- Overlay distance adjustment: + 0, - 4 mm
- Thickness: 0 mm (Standard)

- Recommended Screw
Size 5 raised countersunk head tapping screw or wood screw
- Finish
Nickel



OTHER J95 CONCEALED HINGES:



J95-24/16T



J95-24/0T

FACE PLATE FOR GLASS DOOR GH-J95FP-CR

- Finish
Chrome



> Catalogue page 372/373

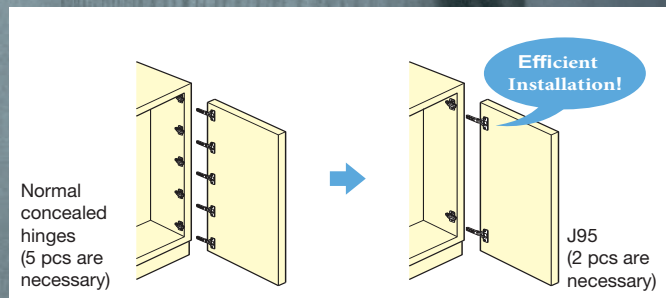

SERIES 100: 100% STAINLESS STEEL

Cup Dia Ø 35 mm
Bore Depth 11 mm
Door Thickness 15-20 mm

100° OPENING
19 mm Overlay

STAINLESS 304 STEEL

> Catalogue page 374

CONCEALED HINGE (STAINLESS STEEL) 100-C46/19 SUS304B

- Features
Screw mount

- Finish
Polished

Cup Dia Ø 35 mm
Bore Depth 11 mm
Door Thickness 15-20 mm

100° OPENING
14 mm Overlay

STAINLESS 304 STEEL

> Catalogue page 375

CONCEALED HINGE (STAINLESS STEEL) 100-C46/14 SUS304B

- Features
Screw mount

- Finish
Polished

Cup Dia Ø 35 mm
Bore Depth 11 mm
Door Thickness 15-20 mm

100° OPENING
9 mm Overlay

STAINLESS 304 STEEL

> Catalogue page 376

CONCEALED HINGE (STAINLESS STEEL) 100-C46/9 SUS304B

- Features
Screw mount

- Finish
Polished

All pictures show the combination of concealed hinge and mounting plate



OUR
HIGH-
LIGHT

Catalogue page 426



DAMPER HINGE HG-JHM16

■ Features

- Hinge with built-in damper to keep lid from slamming shut
- Mortise mount type
- With marking colour on the edge to recognize the model

■ Remarks

Sold in pairs

Still not sure which model is right for your project?
Use the Sasuga-kun Selection Tool!

■ Colour

BL – Black / WT – White



W/black cover



W/white cover

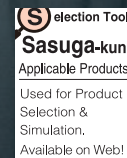
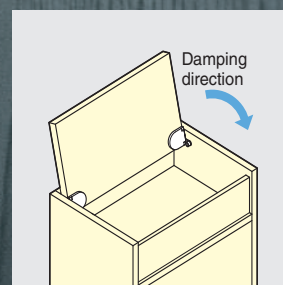

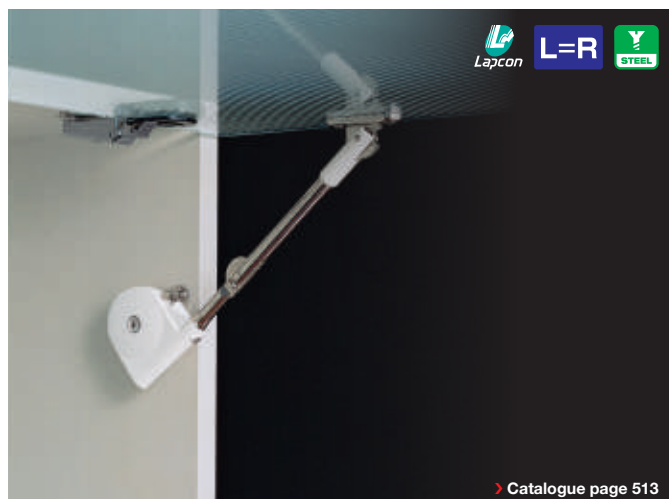

> Catalogue page 513

SOFT-DOWN STAY SDS-C301N

■ **Features**

- For upward-opening doors
- Can be used with concealed, piano or butt hinges
- SDS-C301 is designed to hold the door in closed and opened position
- Non-handed: can be installed either on left or right side

■ **Torque**

- With 1 stay
Torque = 3.92-6.86 N · m (40-70 kgf · cm)
- With 2 stays, the torque will be doubled

■ **Colour**

- Black
- White
- Grey



> Catalogue page 518

ADJUSTABLE SOFT-DOWN STAY NSDX-10

■ **Features**

- For downward-opening doors
- Can be used with piano, butt or drop hinges
- Designed to hold the door in closed position
- Successfully passed for the 30,000 open/close private cycle test
- Opening speed adjustable

■ **Torque**

- With 1 stay
Torque = 1.96-6.86 N · m (20-70 kgf · cm)
- With 2 stays, the torque will be doubled

■ **Finish**

- Nickel



> Catalogue page 509

SELF-OPENING STAY HDS-20S

■ **Features**

- Opens automatically after a small impulse
- Ideal for top-opening lids
- Holds the door at closed position
- Slim design and mounting position maximizes inside space

■ **Torque**

Torque Moment	Model	Qty.
6.9-10.8 N · m	H	1 pair
10.9-14.7 N · m	S	1 pair

■ **Colour**

- Black
- White

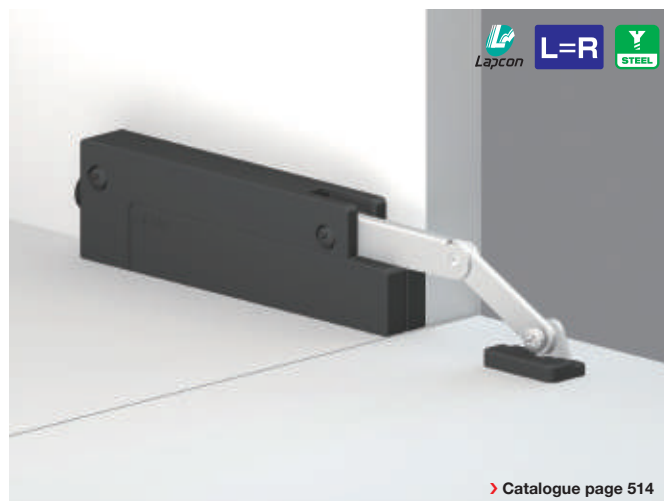

> Catalogue page 514

COMPACT SOFT-DOWN STAY CSD-10-TV

■ **Features**

- Soft-down stay for downward-opening flap doors
- Easy-installed just by aligning the main body to the inside cabinet corner
- Designed for small cabinets such as audio visual furniture
- Opening speed adjustable. The adjustment screw is located on back
- Successfully passed for the 40,000 open/close private cycle test
- CSD-10-TV does not have catch feature. Designed to be used with magnetic catch or touch latch

■ **Torque**

Torque Moment	Model	Qty.
1.0-2.0 N · m	L	1 pc
2.0-3.0 N · m	M	1 pc
3.0-4.0 N · m	H	1 pc

■ **Colour**

- Black
- White

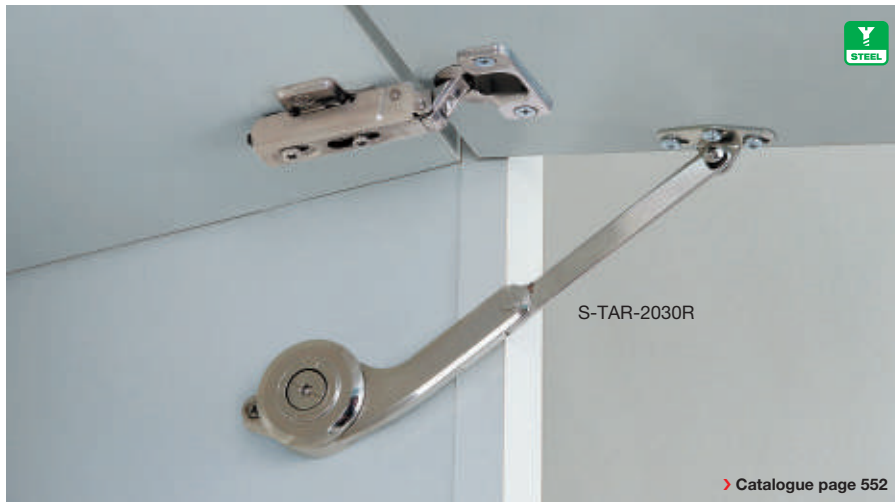

**FREE-STOP STAY (ONE WAY)
S-TAR**

■ **Features**

- Torque stay for upward-opening, downward-opening and top-opening
- Free stop at any position when lifting up the door
- Friction in one direction only
- Light & smooth opening
- Torque adjustable
- Successfully passed for the 30,000 open/close private cycle test

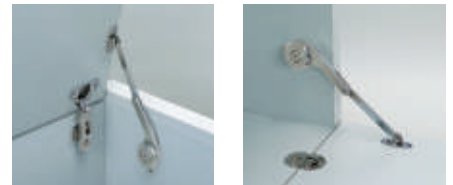

**ULTRA MINI LID STAY
L-100S, L-140S**

■ **Features**

- Holds the lid at open position
- Lift up the lid to release
- Compact design
- Non-handed

■ **Finish**

Polished

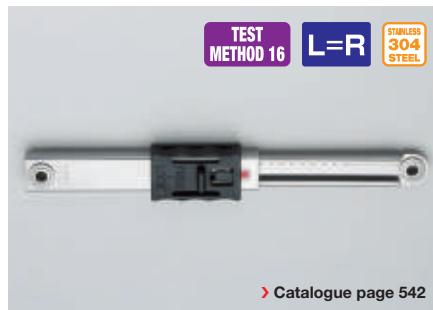

**MINI LID STAY (W/ LOCK)
L-FS140**

■ **Features**

- Locks the lid at multiple angles
- For upward-opening, top-opening and swinging doors
- Can be used singly or in pair

- Non-handed

■ **Finish/Colour**

Polished, Dark Grey

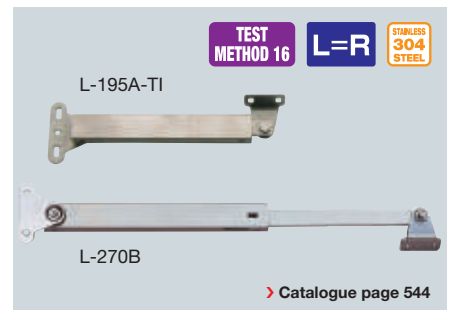

**LID STAY
L-195, L-270**

■ **Features**

- Holds the lid at open position
- Lift up the lid to release
- Only one stay is required per lid

- Non-handed

■ **Finish**

Satin

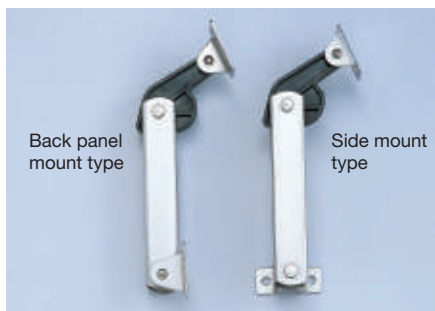

**SPRING LOADED LID STAY
S-YT**

■ **Features**

- Spring mechanism assists lifting the door and holds in opened position

■ **Remarks**

Do not use with concealed hinges

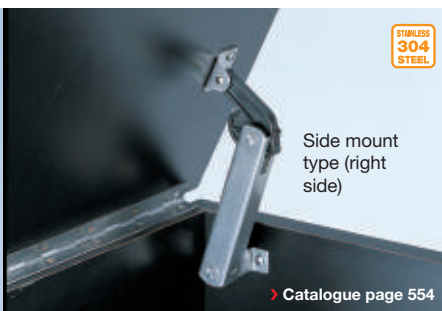

HEAVY DUTY SPRING LOADED LID STAY S-AT

■ **Features**

- Spring mechanism assists lifting the door and holds at any angle (10° - 80°)
- Compact design saves the space inside
- Non-handed

■ **Torque**

With 1 stay
Torque =
6.1-8.8 · Nm
(62-90 kgf · cm)
... S-AT01(S)
Torque =
8.8-11.8 N · m
(90-120 kgf · cm)
... S-AT02(S)



OUR
HIGH-LIGHT
Catalogue page 524

LIFT-ASSIST DAMPER LAD

■ Features

- Lift-assist mechanism with light opening
- Smooth and soft close movement at the end, preventing flaps from slamming shut
- Ideal for counter flaps at bars, restaurants and receptions
- Door thickness: 15–25 mm, max. door thickness with spacer LAD-DP is 40 mm
- Can be installed on the backside of a table with bracket
- Successfully passed for the 100,000 open/close private cycle test

■ Finish

Zincing/Nickel, Chrome

■ Remarks

The Sasuga-kun Selection Tool automatically calculates which model you can use – simply enter the dimensions and weight

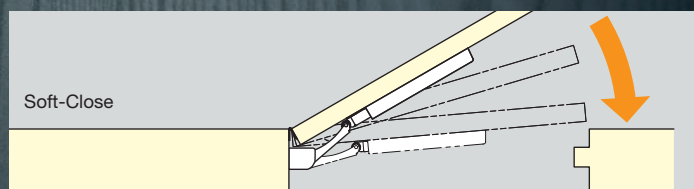
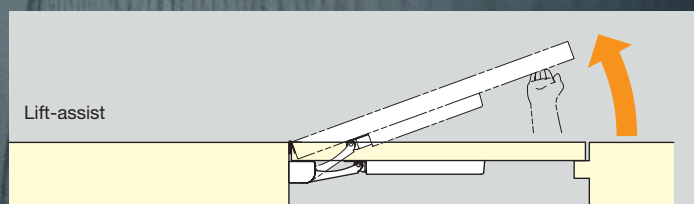



STAINLESS STEEL MINI SLIDE (FULL EXTENSION) SCR3

- **Features**
- Full extension (3 members)
 - Ultra slim profile
 - Special inner member allows smooth movement

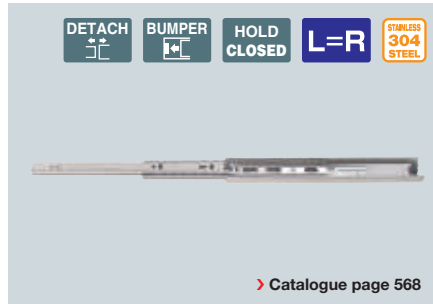

FULL EXTENSION SLIDE ESR-3813

- **Features**
- Full extension
 - The drawer is detachable by lifting the lever
 - With a bumper to avoid metal-to-metal noise at the end of the course
 - The drawer can be held in the fully closed position
 - Non-handed

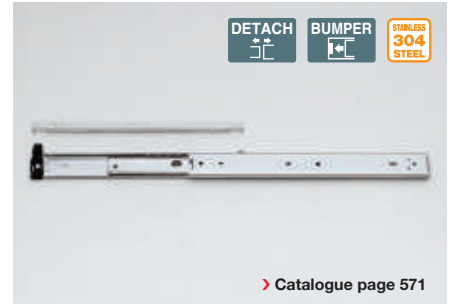

FULL EXTENSION SLIDE ESR3

- **Features**
- Full extension (3 members)
 - The drawer is detachable by lifting the lever
 - With a bumper to avoid metal-to-metal noise at the end of the course

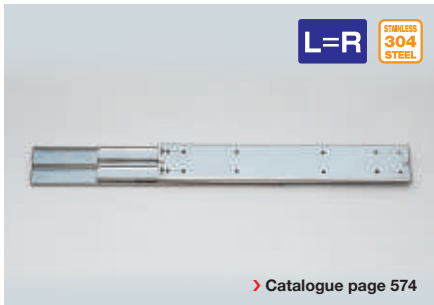

FULL EXTENSION SLIDE ESR10

- **Features**
- Full extension (3 members)
 - Non-handed
 - Heavy duty

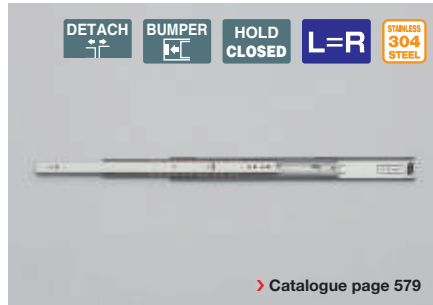

FULL EXTENSION SLIDE ESR4658

- **Features**
- Full extension (3 members)
 - With a bumper to avoid metal-to-metal noise at the end of the course
 - The drawer is detachable by lifting the lever
 - Non-handed

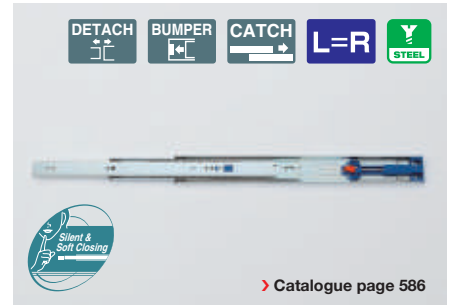

FULL EXTENSION SOFT-CLOSE SLIDE 4670

- **Features**
- Full extension (3 members)
 - With a bumper to avoid metal-to-metal noise at the end of the course
 - The drawer is detachable by lifting the lever
 - Self-closes at 20 mm distance from closed position (250-350 mm slide) and at 36 mm distance from closed position (400-600 mm slide)

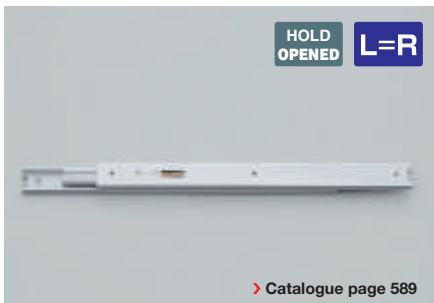

FULL EXTENSION SLIDE AR3-K

- **Features**
- Full extension (3 members)
 - Non-handed
 - The drawer can be held in the fully opened position

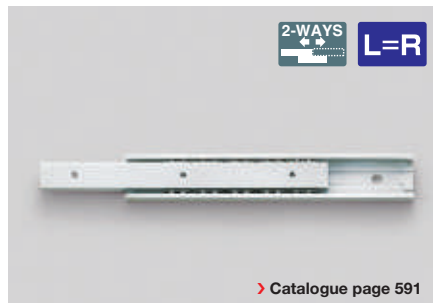

ALUMINIUM MINI SLIDE (2-WAY) ARW2-16

- **Features**
- 3/4 extension slide (2 members)
 - The drawer can be moved to the both directions
 - Thin profile for various applications
 - Light-weight aluminium body
 - Designed without positive stop for easy assembly. Please add a secondary stop if necessary



ALUMINIUM MINI SLIDE (FULL EXTENSION) AR3-16

- **Features**
- Full extension (3 members)
 - Thin profile for various applications
 - Light-weight aluminium body



OUR
HIGH-LIGHT
Catalogue page 718

AVAILABLE NOW:



DOOR DAMPER LDD-V100

■ Features

- Concealed type
- Easy door opening
- Closing speed adjustable even after installation
- Counter plate has 3-way-adjustment function
- Successfully passed for the 100,000 open/close private cycle test
- Special for room doors
- Grips door at final 15°
- Door weight: 40-100 kg
- Width: Max. 900 mm, Thickness: 40-60 mm



DOOR DAMPER LDD-V

■ Features

- Concealed type
- Easy door opening
- Closing speed adjustable (even after installation)
- Counter plate has 3-way-adjustment function
- Successfully passed for the 100,000 open/close private cycle test
- Special for room doors
- Grips door at final 10°
- Door weight: 15-40 kg
- Width: max. 900 mm, Thickness: min. 33 mm



**OUR
HIGH-
LIGHT**
Catalogue page 629



reddot award 2017
winner



MonoFlat **LIN-X** hinge.
HINGE LIN-X1000
(heavy duty)

■ Features

- Unique design & easy installation
- Lateral swing mechanism
- Allows doors to swing out laterally in a small radius, ideal for tight front space application
- Full access to cabinet
- Door will not get in the way when fully opened
- Smooth movement
- Free stop & soft-close
- Door can be stopped in any position and closes softly
- 4-way adjustable
- Adjustment in vertical (± 7 mm), horizontal (± 7 mm), depth (± 5 mm) and parallel ($\pm 3^\circ$)



Various Applications

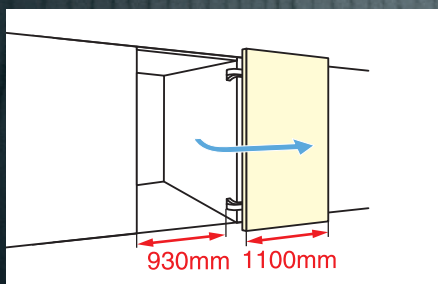
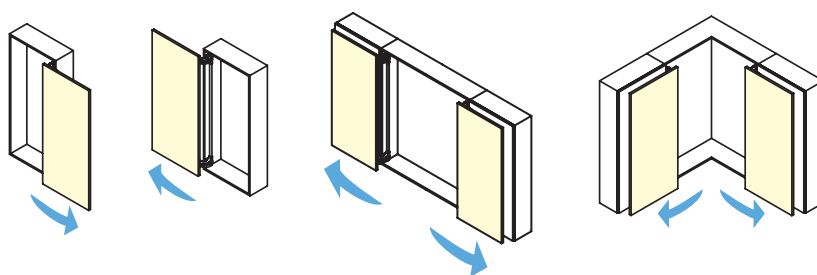

Minimal space required (max. door width 1,100 mm/effective opening width 930 mm). The door stays out of the way when opening and closing it.

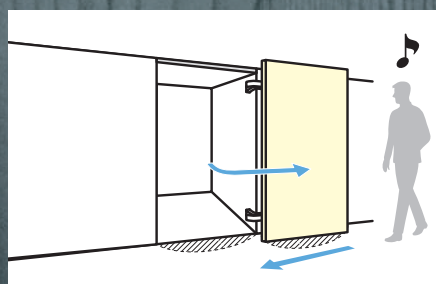

With LIN-X1000

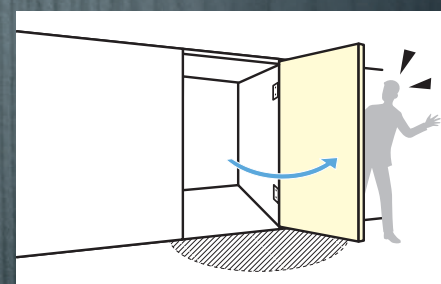

With common swing door



TWIN WHEEL CASTER GX60P

- **Features**
 - Thanks to the light weight aluminium body, the caster is strong and smart looking
- Twin wheel caster with excellent stability

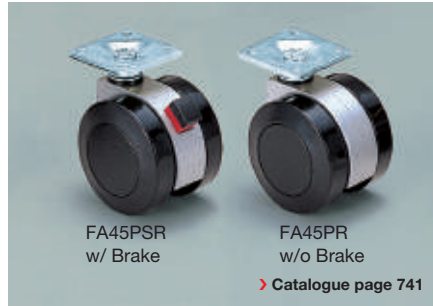

TWIN WHEEL CASTER (PLATE TYPE) FA45P

- **Features**
 - Thanks to the light weight aluminium body, the caster is strong and smart looking



SELF-LEVELING GLIDE SAJ

- **Features**
 - Gel inside adjusts automatically to uneven floor
 - Self adjustment up to 3 mm or 6 mm
- Suited for environments between -20°C and 75°C
- **SAJ-Wrench** (sold separately)



MULTI-PURPOSE LID (W/DAMPER) AD-DH

- **Features**
 - Lid equipped with damper
 - Corrosion resistance
 - Wide opening
 - Operating temperature: 0°C - 40°C
- **Finish**
 - Satin



STAINLESS STEEL FUNNEL AE-DH

- **Features**
 - Disposal of liquids
- **Finish**
 - Satin
 - Mirror

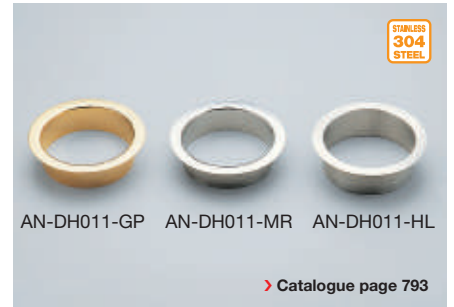

RING COVER FOR REFUSE BOX AN-DH

- **Features**
 - Corrosion resistant
 - Wide variations (size/depth/finish)
- **Finish**
 - Gold
 - Mirror
 - Satin
 - Gold + Clear



MULTI-PURPOSE LID (W/DAMPER) AD-KH017-HL

- **Features**
 - Lid equipped with damper
 - Corrosion resistant
 - Wide opening
 - Operating temperature: 0°C - 40°C
- **Finish**
 - Satin

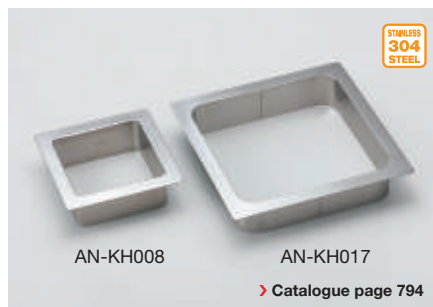

SQUARE COVER FOR REFUSE BOX AN-KH

- **Features**
 - Corrosion resistant
- **Finish**
 - Satin



MULTI-PURPOSE LID (W/DAMPER) AZ-GD232

- **Features**
 - Lid equipped with damper
 - Opening angle adjustable: 45° - 85°
 - With anti-pinching plates
 - Corrosion resistant
- **Finish**
 - Satin



STAINLESS
304
STEEL

> Catalogue page 799

MULTI-PURPOSE LID (W/HANDLE) AZ-HD

- **Features**
- Easy opening with handle
- Corrosion resistant

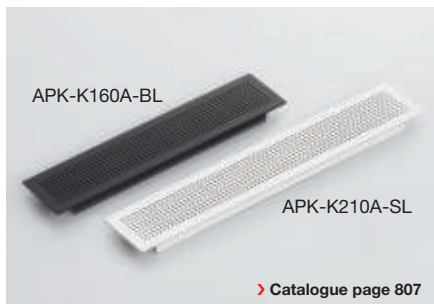

APK-K160A-BL

APK-K210A-SL

> Catalogue page 807

VENTILATOR APK-K

- **Features**
- Smart and simple design
- Small holes (dia. 1.5 mm) prevents insects from entering
- Removable ventilator and cable grommet allows easy cleaning



> Catalogue page 807

INTRODUCTION OF RECESSED PULL WITH VENTILATOR UTA-105

- **Features**
- With ventilator function
- Excellent chemical resistance

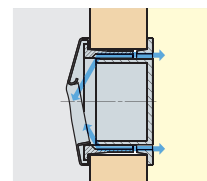

STAINLESS
304
STEEL

> Catalogue page 814

VENTILATOR SAD

- **Features**
- Max. exhaust area approx. 1880 mm²
- approx. 3800 mm²
- Model SA-D150
- SA-D200



STAINLESS
304
STEEL

> Catalogue page 815

VENTILATOR SAM

- **Features**
- Max. exhaust area approx. 290 mm²
- approx. 570 mm²
- approx. 1000 mm²
- approx. 2150 mm²
- approx. 4480 mm²
- Model SA-M37
- SA-M45
- SA-M60
- SA-M85
- SA-M120

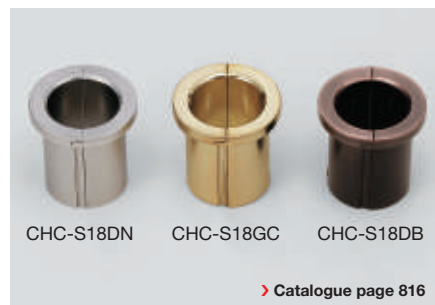

CHC-S18DN

CHC-S18GC

CHC-S18DB

> Catalogue page 816

CABLE GROMMET CHC-S18

- **Features**
- Can be split into two parts for easy exchange of LAN cables
- **Finish**
- Nickel
- Gold
- Antique Brass
- Black



LN72-WT

LN72-BL

> Catalogue page 820

CABLE GROMMET LN72

- **Features**
- Double sided cable grommet
- Applicable board thickness: 30 mm - 40 mm. Also available for 18 mm - 30 mm thickness board by cutting the slit on
- body
- Lid is removable for wide opening
- **Colour**
- White
- Black



LN72P-CR

LN72P-DC

LN72P-GC

> Catalogue page 820

CABLE GROMMET LN72P

- **Features**
- Without cap version of LN72S
- **Finish**
- Chrome
- Dull Chrome
- Gold



LN72SF-WT + LN72SF-ST-WT

LN72SF-BL + LN72SF-ST-BL

LN72SF-WT + LN72SF-STMAP

LN72SF-BL + LN72SF-STMAO

> Catalogue page 821

CABLE GROMMET LN72SF

- **Features**
- 4 different finishes available
- Cap is removable for wide opening
- **Colour Main Body**
- White
- Black
- **Colour Surface Sheet (sold separately)**
- White
- Black
- Maple
- Mahogany

LAMP®

The SUGATSUNE difference

HANDLES, PULLS & KNOBS

HOOKS

BRACKETS & SHELVING SYSTEMS

CATCHES & LATCHES

LOCKS

HINGES

LID SUPPORTS

DRAWER SLIDES

WARDROBE & CABINET DOOR HARDWARE

ARCHITECTURAL DOOR HARDWARE

CASTERS & LEVELING GLIDES

MISCELLANEOUS

Precision Quality

Our products are designed to meet your exacting standards. SUGATSUNE quality craftsmanship ensures years of trouble-free operation.

Vast Selection

Choose from more than 20,000 items, all manufactured by SUGATSUNE or produced exclusively for us. Each product is created to meet your every need in the global marketplace with extensive local distribution and large inventory.

Customer Satisfaction

You can rely on the SUGATSUNE combination of product and availability to ensure complete satisfaction. Experience our exemplary customer service from the moment of first contact to the time an order is shipped.

Advanced Design

SUGATSUNE is constantly innovating advanced new hardware solutions. Our design and engineering staff stay abreast of the latest trends to bring you exemplary products.



Find further details and products in our extensive product catalogue No.240

SUGATSUNE

SUGATSUNE Europe GmbH

Heerdter Lohweg 87-89
40549 Düsseldorf Germany
Tel.: +49 (0) 211 / 53812 900
Fax: +49 (0) 211 / 53812 901
sales@sugatsune.eu
www.sugatsune.eu

Now on Facebook and LinkedIn

HEAD OFFICE

SUGATSUNE KOGYO CO., LTD.

Tokyo, JAPAN
Tel.: +81 (0)3 3866 2260
Fax: +81 (0)3 3866 4447
export@sugatsune.co.jp
www.sugatsune-intl.com

ASIA

SUGATSUNE SHANGHAI CO.,LTD.

Shanghai, CHINA
Tel.: +86-21-3632-1858
Fax: +86-21-3632-1868
lamp@sugatsune.com.cn
www.sugatsune.com.cn

Guangzhou, CHINA

Tel.: +86-20-6639-3552
Fax: +86-20-6230-9772
lamp@sugatsune.com.cn
www.sugatsune.com.cn

SUGATSUNE KOGYO INDIA PRIVATE LIMITED

Mumbai, INDIA
Tel.: +91-22-28314490/91
sales@sugatsune.in

EUROPE

SUGATSUNE KOGYO (UK) LIMITED

Reading, UK
Tel.: +44-118-9272-955
Fax: +44-118-9272-871
sales@sugatsune.co.uk
www.sugatsune.co.uk

NORTH AMERICA

SUGATSUNE AMERICA, INC.

California, USA
Tel.: +1-310-329-6373
Fax: +1-310-329-0819
sales@sugatsune.com
www.sugatsune.com

Chicago, USA

Tel.: +1-312-461-1081
Fax: +1-312-461-1082
chicagoshowroom@sugatsune.com
www.sugatsune.com/chicago/