



GEEPLUS

Open Frame Solenoid SK-A0832

Device drawn in energised condition
 Life Expectancy >250K cycles
 Leadwires UL1007, 26AWG, 240mm

Plunger Mass 14grammes
 Total Mass 82 grammes

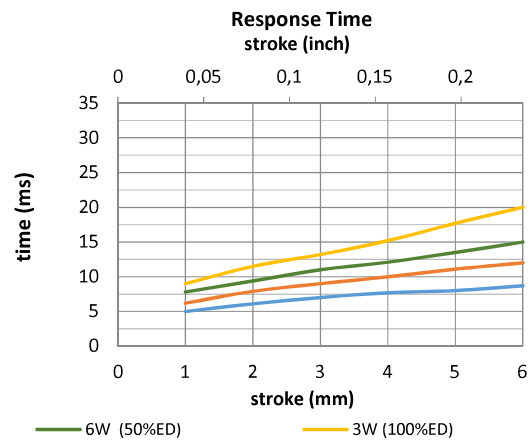
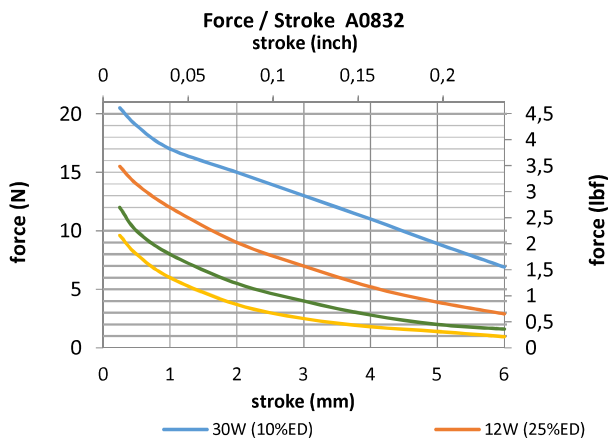
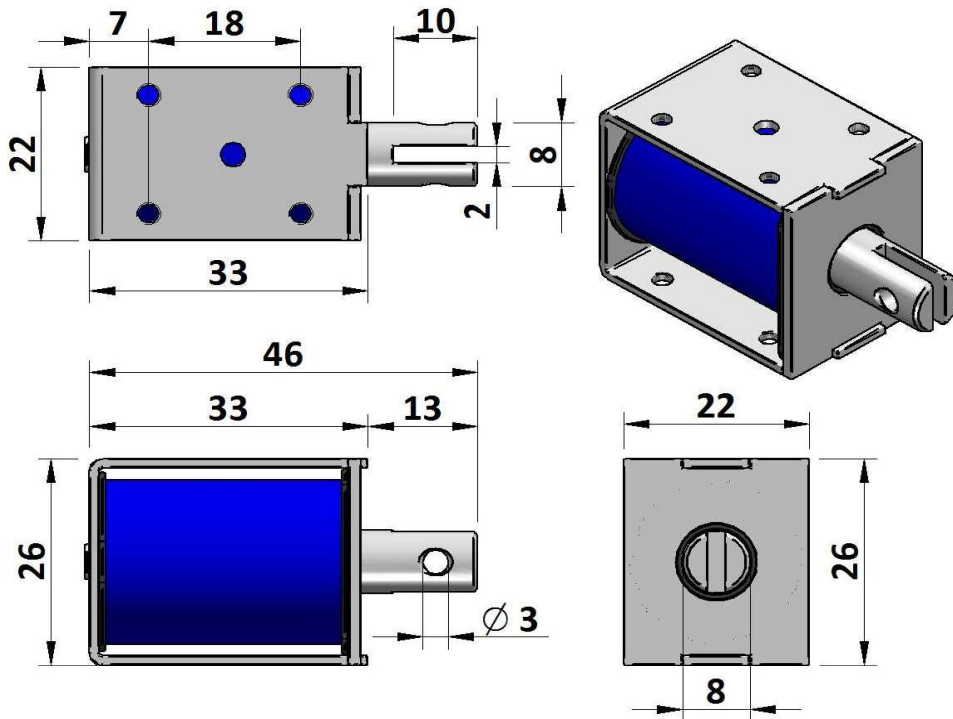

Data at 20°C, device performance measured without heat sink

duty cycle = $\frac{\text{"on" time}}{\text{"on" time} + \text{"off" time}} \times 100\%$			100% cont.	50% or less	25% or less	10% or less
Max. "on" time in seconds			∞	100	36	7
watts at 20°C			3,0	6,0	12,0	30,0
ampere-turns at 20°			571	807	1142	1805
AWG no.	resistance	number of turns	volts DC			
	$\Omega \pm 10\%$ (at 20°C)					
SK-A0832-6v	12	1150	6,0	8,5	12,0	19,0
SK-A0832-12v	46	2300	12,0	17,0	24,0	38,0
SK-A0832-24v	186	4430	24,0	34,0	48,0	76,0
SK-A0832-48v	743	8410	48,0	68,0	96,0	152

Insulation Resistance >100MΩ, 500VDC Megger

Dielectric Strength 500VAC, 50/60Hz, 1 minute

Class A (105°C) insulation class

Geeplus reserves the right to change specifications without notice

www.geeplus.com