



**GEEPLUS**

## Open Frame Solenoid RD-A1264

Device drawn in energised condition  
 Life Expectancy >250K cycles  
 Leadwires UL1007, 22AWG, 320mm

Plunger Mass 49 grammes  
 Total Mass 337 grammes

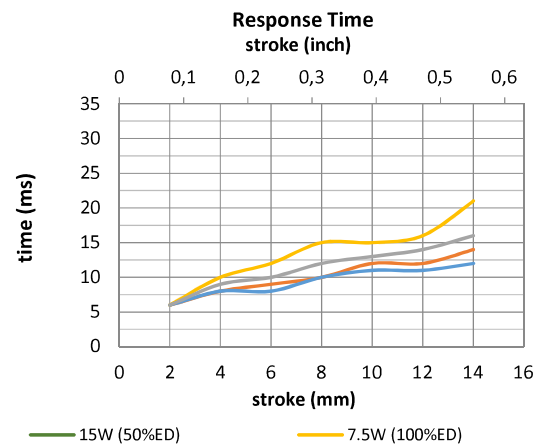
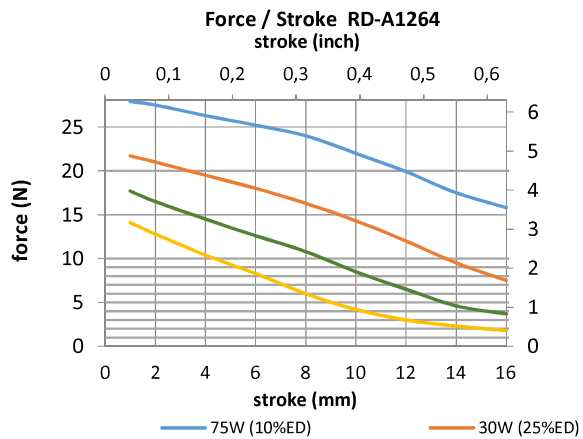
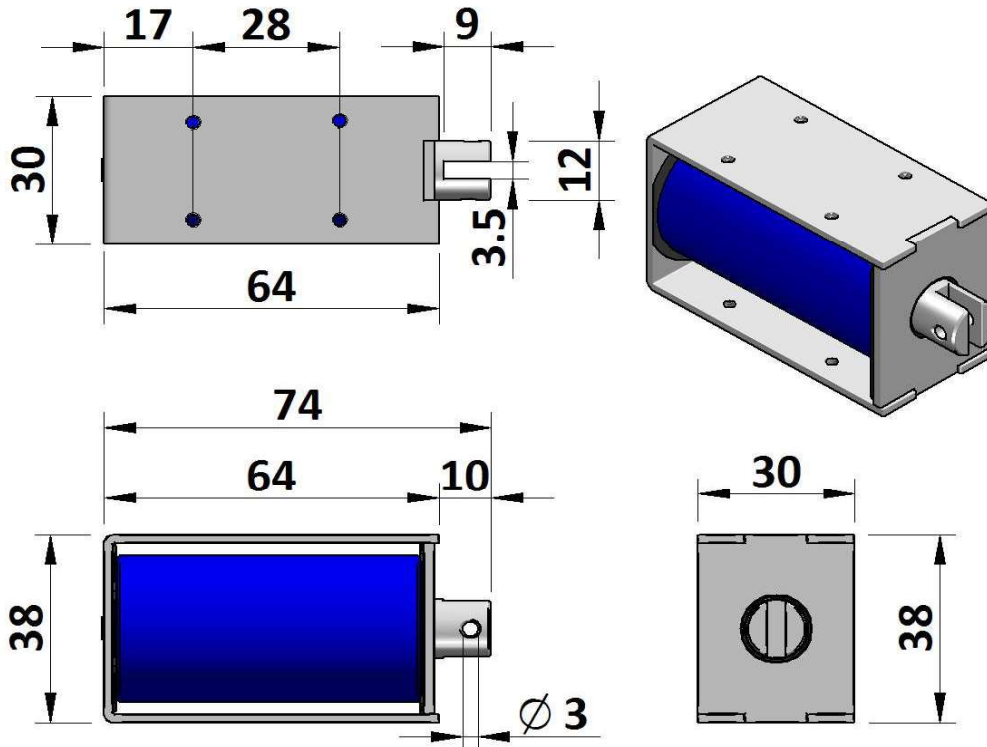

Data at 20°C, device performance measured without heat sink

duty cycle = $\frac{\text{"on" time}}{\text{"on" time} + \text{"off" time}} \times 100\%$		100% cont.	50% or less	25% or less	10% or less	
Max. "on" time in seconds		∞	713	305	95	
watts at 20°C		7,5	15,0	30,0	75,0	
ampere-turns at 20°						
AWG no.	resistance Ω±10% (at 20°C)	number of turns	volts DC			
RD-A1264-6v	4,8		6,0	8,5	12,0	19,0
RD-A1264-12v	19,2		12,0	17,0	24,0	38,0
RD-A1264-24v	76,8		24,0	34,0	48,0	76,0

Insulation Resistance >100MΩ, 500VDC Megger

Dielectric Strength 500VAC, 50/60Hz, 1 minute

Class A (105°C) insulation class

Geeplus reserves the right to change specifications without notice

[www.geeplus.com](http://www.geeplus.com)